



USED LUBE OIL RE-REFINING

A SUCCESSFUL INVESTMENT

PRESENTATION



STP - Studi Tecnologie Progetti Srl
Engineering & Contractor
Rome, Italy



Oil recycling proves its worth

USED LUBE OIL RE-REFINING

Re-refining of used lube oil is an economically attractive recycling method in terms of resources conservation and environment protection. It allows processing of hazardous material in a safe and effective way to recover an high quality base oil product.

This result in a strong economic incentive for re-refining considering lube oil price.

Re-refining can produce base oils or VGO distillate that is a suitable feedstock to FCC or HDC Refinery Units.

Used lube oil is generally a mixture of different types and grades of used lube oils, coming from motor crankcases and industry users.

Used lube oil is made up of a multitude of small individual batches collected at garages, maintenance shops, transportation companies and industries and depends on local situation, seasonal consumption, handling practice at the collection source and collecting system organization.



2 liters of Used Lube Oil

give

1,5 liters of Rerefined Oil



LUBE OIL LIFE CYCLE

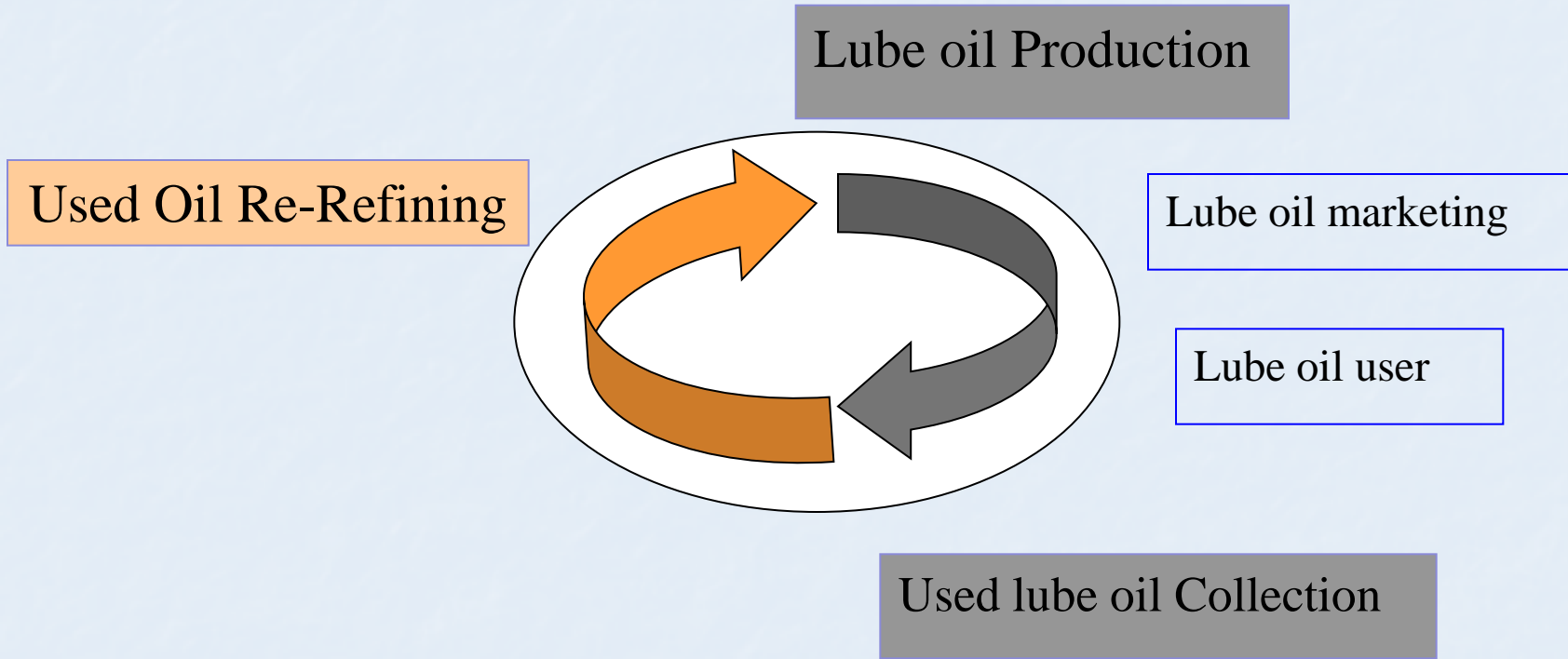



USED LUBE OIL RE-REFINING



USED LUBE OIL CYCLE

When refilling lubricant
on motor crank-case....



used lube oil is collected and
re-refined...



to give Re-refined Base Oil for
lubricant production





USED LUBE OIL RE-REFINING ADVANTAGES

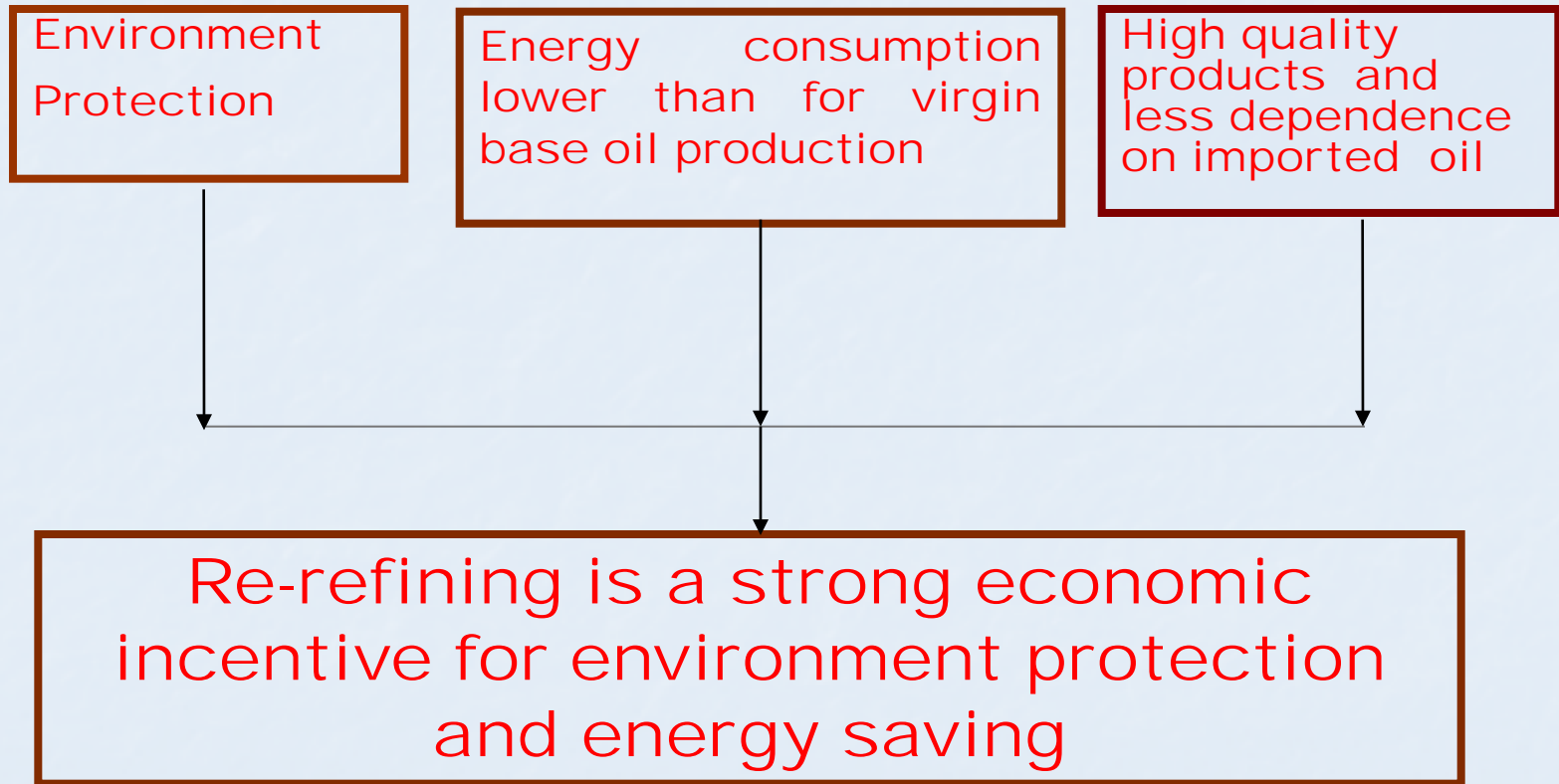



USED LUBE OIL COLLECTION

Collection of used lube oil is the starting point for a successful Re-refining.

Re-refining depends on collection effectiveness and used lube oil availability.

Efficient collection facilities are a necessity for Re-refining in relation to:

- Availability of used lube oil (quantity)
- Composition of used lube oil (quality)

SUCCESS OF RE-REFINING

depends on the

COLLECTION SYSTEM



USED LUBE OIL COLLECTION STRATEGY

- Investigation on used lube oil providers
- Division of the territory in Areas and Sectors
- Storage capacity of collection centres
- Transport network and drivers formation
- Pre-selection laboratory
- Segregation of contaminants

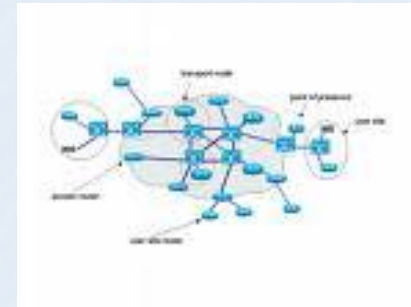



USED LUBE OIL RE-REFINING

Re-refining removes all the contaminants from used lube oil to recover base lube oil product.

During the last years many factors have obliged rerefiners to look for alternative Re-refining process, such as:

- increased use of additive packages in the formulation of finished lube oil and by consequence higher level of contaminants in the used oil
- increased amount of thermal degradation products due to longer mileage of the lubricants
- pollution problems related to the disposal of acid sludges and spent clay from the traditional acid/clay re-refining

Among the available today processes, STP Re-refining offers a low energy high yield operation, high quality products and absence of noxious wastes or by products.



USED LUBE OIL RE-REFINING



**STP is pioneer on Used Lube Oil Re-refining
since more than 20 years.**

**STP has implemented several Re-refining Plants worldwide
and is providing the last generation of Re-refining Process
based on unicum open art know-how.**





Advantages of STP Re-refining Process

- High flexibility towards feedstock quality and composition
- High process yield. The lube oil recovery is more than 95%
- High separation selectivity, removal of contaminants and production of high quality base oils
- Low energy and low utility consumption
- High onstream efficiency without corrosion, fouling, coking
- Environment safeguarding operation
- Management of all odorous compounds to eliminate malodorous and toxic emissions
- Capital investment and operating cost highly competitive



STP Re-refining Process

STP Re-refining process removes all the contaminants from the used lube oil and recovers a distillate product as VGO or high quality base oil either API Group I by chemical finishing or API Group II by hydrofinishing.

STP Re-refining process does not release harmful or pollutant wastes to be disposed and is therefore environment friend.

Effluents are oily drains / low BOD/COD oily process water sent to treatment before disposal and process off gas sent to thermal oxidizer for combustion and destruction according to environmental law and regulations.





API Definitions for Base Oils

For the purpose of guidelines on Base Oil Quality Assurance and Base Oil Interchange, base stocks are divided into six **base stock groups** according to defined physical and chemical characteristics as follows:

Group I Base stocks containing less than 90 mass percent saturates and/or greater than 0.03 mass percent sulphur and having a viscosity index greater than or equal to 80 and less than 120.

Group II Base stocks containing greater than or equal to 90 mass percent saturates and less than or equal to 0.03 mass percent sulphur and having a viscosity index greater than or equal to 80 and less than 120.



API Definitions for Base Oils (cont'd)

- Group III** Base stocks containing greater than or equal to 90 mass percent saturates and less than or equal to 0.03 mass percent sulphur and having a viscosity index of greater than or equal to 120.
- Group IV** Base stocks are polyalphaolefins (PAO)
- Group V** All base stocks not included in Groups I, II, III, IV or VI.
- Group VI** Base stocks are polyinternalolefins (PIO)

The analytical methods to be used in the definition of the above base stock groups are:

PROPERTY	TEST METHOD
Saturate content	ASTM D 2007
Viscosity index	ASTM D 2270
Sulphur content	ASTM D 2622
	ASTM D 4294
	ASTM D 4927
	ASTM D 3120



STP Re-refining Process

Unit Operations

- Dehydration
- Gas oil removal
- Vacuum distillation
- Finishing and final fractionation



PROCESS DESCRIPTION

- **Dehydration:** used oil is partly vaporized at atmospheric pressure and 160°C to remove water, gasoline, light contaminants (solvents, glycols, lighter organic). Water and lights are condensed and recovered.
- **Gasoil removal:** dehydrated oil is stripped under vacuum for light gasoil removal and flash point adjustment of lube oil.
- **Vacuum distillation:** oil from gasoil stripper is sent to vacuum distillation to recover VGO oil fraction from “heavier than” contaminants.
Vacuum distillation is carried out under high vacuum conditions, high temperature and by thin film evaporator.

Thin film evaporator achieves high selectivity and oil purification from metals, heavy polymers, carbon, dust.



PROCESS DESCRIPTION (cont'd)

Thin film evaporator is a vertical cylindrical shell enclosed in an heating jacket with an internal rotor distributing a thin layer of oil on the heated wall, by means of rotating blades.

By the action of rotor (electrically driven) high turbulence and back mixing occur in the thin layer of the oil film and product degradation at high temperature is avoided.

Main features of thin film evaporator are:

- ❖ short residence time (in order of magnitude of 10 seconds) by mechanical agitation of oil on the heat transfer surface;
- ❖ high heat transfer rate through the film;
- ❖ efficient and regenerative cleaning of the contact surface

Cracking and fouling problems are avoided by keeping low residence time, low wall temperature and high flow turbulence.

Lube oil is recovered as distillate while heavy components, additives, metals and degradation products are concentrated in the bottom residue.

THIN FILM EVAPORATOR

❖ OPERATING PRINCIPLE

A Thin Film Evaporator consists of a cylindrical shell with internal rotor and external heating jacket

❖ FEED

The feed is distributed by the rotor blades and spread on the heated wall to form an highly turbulent thin layer.

❖ PRODUCTS

Light fractions are evaporated and flow out up towards the top

Heavy components flow in a spiral path down to the bottom

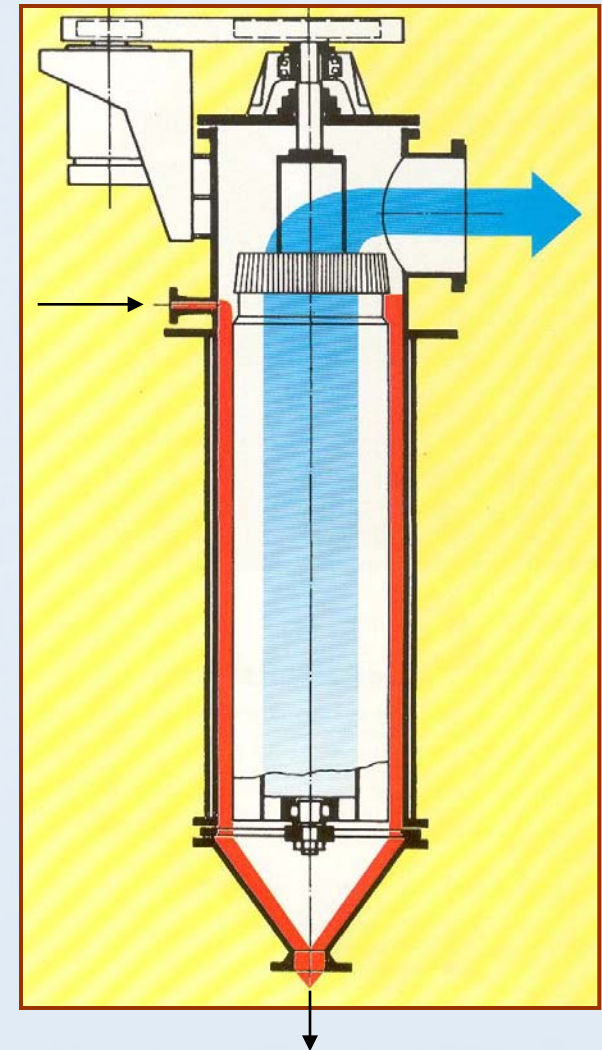

THIN FILM EVAPORATOR

❖ FEATURES

- Short residence time and high turbulence in the film give high heat transfer coefficient and avoid overheating, cracking and fouling
- High evaporation rate is obtained by a simple pass
- High oil yield is achieved without degradation or polymerization of heat sensitive material
- High onstream factor and easy maintenance

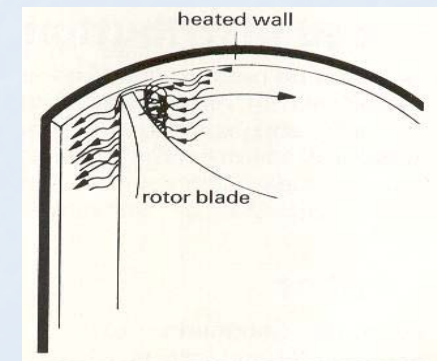
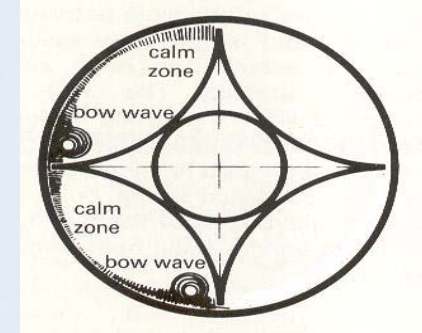



PROCESS DESCRIPTION (cont'd)

- **Finishing and final fractionation** : vacuum distillate is further finished to improve product quality.

Finishing is done by Chemical Reactor or Hydrofinishing (Base oil API Group II production).

Hydrofinishing provides deep removal of further contaminants such as chlorinated, sulfurous, and oxygenated organic compounds and polyaromatic hydrocarbons.

Finished oil is then fractionated to produce light oil (SN-150) and heavy oil (SN-500).



STP Re-refining Process

- ✓ Advanced vacuum system for high vacuum level stability, based on the combined use of steam ejectors and individual tubular condensers.
- ✓ High efficiency/low pressure drops special packing in lieu of normal packing (pall rings + grids), to reduce pressure drops and increase oil yield and product separation.
- ✓ Special type of pumps and instrumentation for critical services.
- ✓ Use of antifouling to reduce fouling and maintenance/cleaning operation.
- ✓ Proprietary design Chemical Reactor
- ✓ Two Stage hydrofinishing (demetallization + hydrogenation) and high activity catalyst, to upgrade the product quality in accordance with Api Group II specification.

USED LUBE OIL CHARACTERISTICS

(TYPICAL)

➤ Specific gravity	0.915		
➤ Viscosity, cst			
at 40°C	130		
at 100°C	15		
➤ Composition, wt%			
	Min.	Norm.	Max
Water	2	5	10
Light ends	1	2	4
Gasoil	2	5	8
Lube oil fraction	65	75	80
Asphaltic residue	10	13	15



➤ ASTM D-1160 Vacuum distillation of dry oil (corrected at atm pressure)

<u>Vol %</u>	<u>Temperature (°C)</u>
IBP	150
5	270
10	325
20	395
30	420
40	430
50	440
60	450
70	470
80	505
90	570
FBP	590

USED LUBE OIL RE-REFINING

USED LUBE OIL PRESELECTION TEST

- | | |
|---|---------|
| ■ PCB / PCT, wt ppm | 25 max |
| ■ Cl, wt % | 0.5 max |
| ■ S, wt % | 1.5 max |
| ■ Saponification N ^o , mgKOH/g | 20 max |
| ■ Heavy fuel oil (drop test) | pass |
| ■ Fatty acids (lux test) | pass |





USED LUBE OIL RE-REFINING



PRODUCTS CHARACTERISTICS

LIGHT GASOIL

Specific gravity at 15 °C	0.850
End point, °C	360
Viscosity, cst at 40 °C	3-5
Sulfur, wt%	0.1
Cetane Index	50-55
Colour	L 1.0
Flash point, °C	55



Gasoil can be used as substitution fuel in the Plant or as light fuel oil in industrial fired heaters and/or boilers.



USED LUBE OIL RE-REFINING



PRODUCTS CHARACTERISTICS

VGO

Distillation range, °C	370 - 550
Specific gravity at 15°C	0.875
Viscosity, cst @ 40°C	27 - 35
cst @ 100°C	4 - 5
Flash point, °C	210 min
Sulfur, wt%	0.25
CCR, wt%	0.1 max
TAN, mgKOH/g	0.1 max
Ashes, wt%	0.2
Metals content, wt ppm	10 max



VGO is used as feedstock to FCC or HDC Refinery Units



USED LUBE OIL RE-REFINING



PRODUCTS CHARACTERISTICS

RE-REFINED BASE OILS

API GROUP II

Characteristics	Base Oil SN-150	Base Oil SN-450
Specific gravity at 15 °C	0.870	0.885
Viscosity, cst at 40 °C	25-32	85-95
Sulfur, wt%	<0.03	<0.03
Saturates, wt%	≥90	≥90
CCR, wt%	<0.01	<0.01
Colour	L 1.0	1.5
TAN, mg KOH/g	<0.01	<0.01
Flash point, °C	220	260
Pour point, °C	-3	-6
Metals, ppm	absent	absent





PRODUCTS CHARACTERISTICS

REREFINED BASE OILS

API GROUP II

Characteristics	Base Oil	Base Oil
	SN-150	SN-450
VI	100	100
PCB, wt ppm	<1	<1
PCT, wt ppm	<5	<5
PNA, wt ppm	<1000	<1000
Cl, wt ppm	<1	<1
Cu corrosion	1a	1a
Noack evaporation loss	15.0	2.5
Saponification N°	<0.5	<0.5
Demulsification N°	10	10
Oxydation stability		
CCR increase, %	0.10	0.15
Viscosity ratio @ 40°C	1.09	1.1
Color stability	1.0	1.0





USED LUBE OIL RE-REFINING

PRODUCTS CHARACTERISTICS



RE-REFINED BASE OILS

API GROUP I

Characteristics	Base Oil SN-150	Base Oil SN-500
Specific gravity at 15 °C	0.870	0.885
Viscosity, cst at 40 °C	25-32	90-100
Sulfur, wt%	0.20	0.25
CCR, wt%	0.05	0.07
Colour	2.0	2.5
TAN, mg KOH/g	0.03	0.05
Flash point, °C	220	260
Pour point, °C	-3	-6
Metals, ppm	L 10	L 10





PRODUCTS CHARACTERISTICS

ASPHALTIC RESIDUE

Specific gravity at 15 °C	0.950 - 1.050
Viscosity, cst	
at 40 °C	10,000
at 100 °C	80
Sulfated ash, wt%	3-4
Sulfur, wt%	1-2
Penetration, mm/10 at 25 °C	200-400
Softening point, °C	15-20

Residue contains high quantity of polymers and metals and can be used for asphalt blending, production of paving asphalt, bitumen protective covering or as fuel in the cement factories.



OVERALL MATERIAL BALANCE

Used Lube Oil	100
----------------------	------------

PRODUCTS

Water and Light Ends	7
-----------------------------	----------

Light Gasoil	5
---------------------	----------

Lube Oil	75
-----------------	-----------

Asphaltic Residue	13
--------------------------	-----------



OPERATING REQUIREMENT

Utilities Consumption (per MT of Used Lube Oil)

	VGO or Base oil API Group I production	Base oil API Group II production
Electric power, Kwhr	50	60
Cooling water, m ³	60	70
Steam, Kg/hr (Note 1)	2,000	2,000
Fuel, 10 ³ Kcal	350	570
Chemical, Kg	7.5	-
Hydrogen, Nm ³	-	35

Note:

1 – Steam consumption for vacuum systems does not depend on used lube oil capacity.



OPERATION STAFF

Operating labour requirements will depend on factors such as Plant operating philosophy, geographical location, whether or not the Plant is part of an existing complex.

Based on STP experience with similar Plant, the estimated typical labor and technical staff requirement is as follows:

Plant Manager	1
Plant Operation:	
• Supervisor/Board person (1 per shift)	4
• Operators (2 per shift)	8
Maintenance/Workshop	
• Supervisors	1
• Workers	4
Laboratory	2
	<hr/>
Total	20

The staffing estimate is provided as a guideline and is intended for preliminary assessment.



USED LUBE OIL RE-REFINING



Utilities Systems & Offsite facilities at the service of the Re-refining Unit

- Electric power system
- Steam system
- Cooling water system
- Compressed air system
- Fire fighting system
- Sewage and WWT
- Flare system (in case of Hydrofinishing)
- Used oil and Products storage and loading system



ISBL Re-refining Unit includes DCS system, Thermal oil system, Thermal oxidizer, Process water stripper and post treatment (chemox)

LAND AREA REQUIREMENT

The Used Oil Re-refining Unit is a very compact facility.

The plot size required for the Unit will depend upon the particular circumstances of the proposed location.

The estimated land area required for a 50,000 MTPY Re-refining Unit on a battery limits basis is as follows :

Production of Base Oil API Group I or VGO (without Hydrofinishing)	1,400 sq.mt
Production of Base Oil API Group II (with Hydrofinishing)	2,400 sq.mt

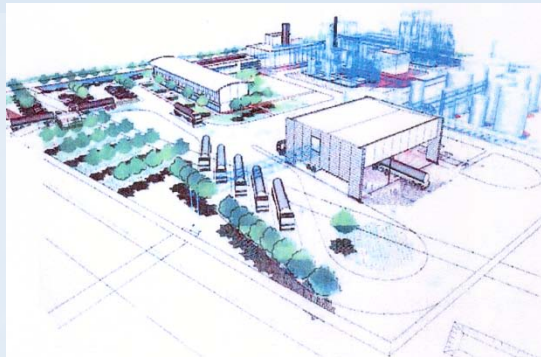



Used Lube Oil Re-refining

FLOW SCHEMES



USED LUBE OIL RE-REFINING



Used Lube Oil Re-refining

Block Scheme

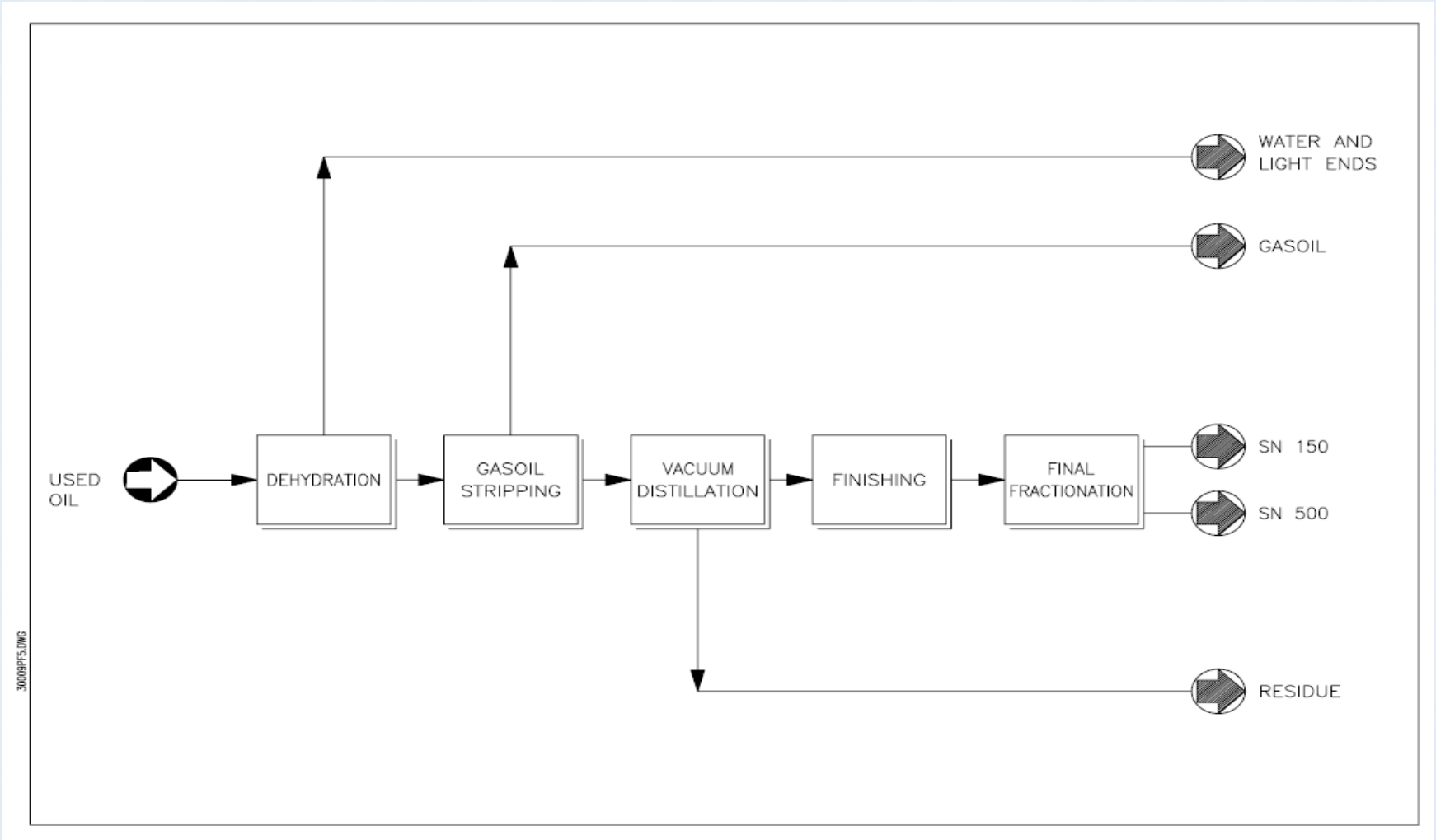



USED LUBE OIL RE-REFINING



Used Lube Oil Re-refining VGO production

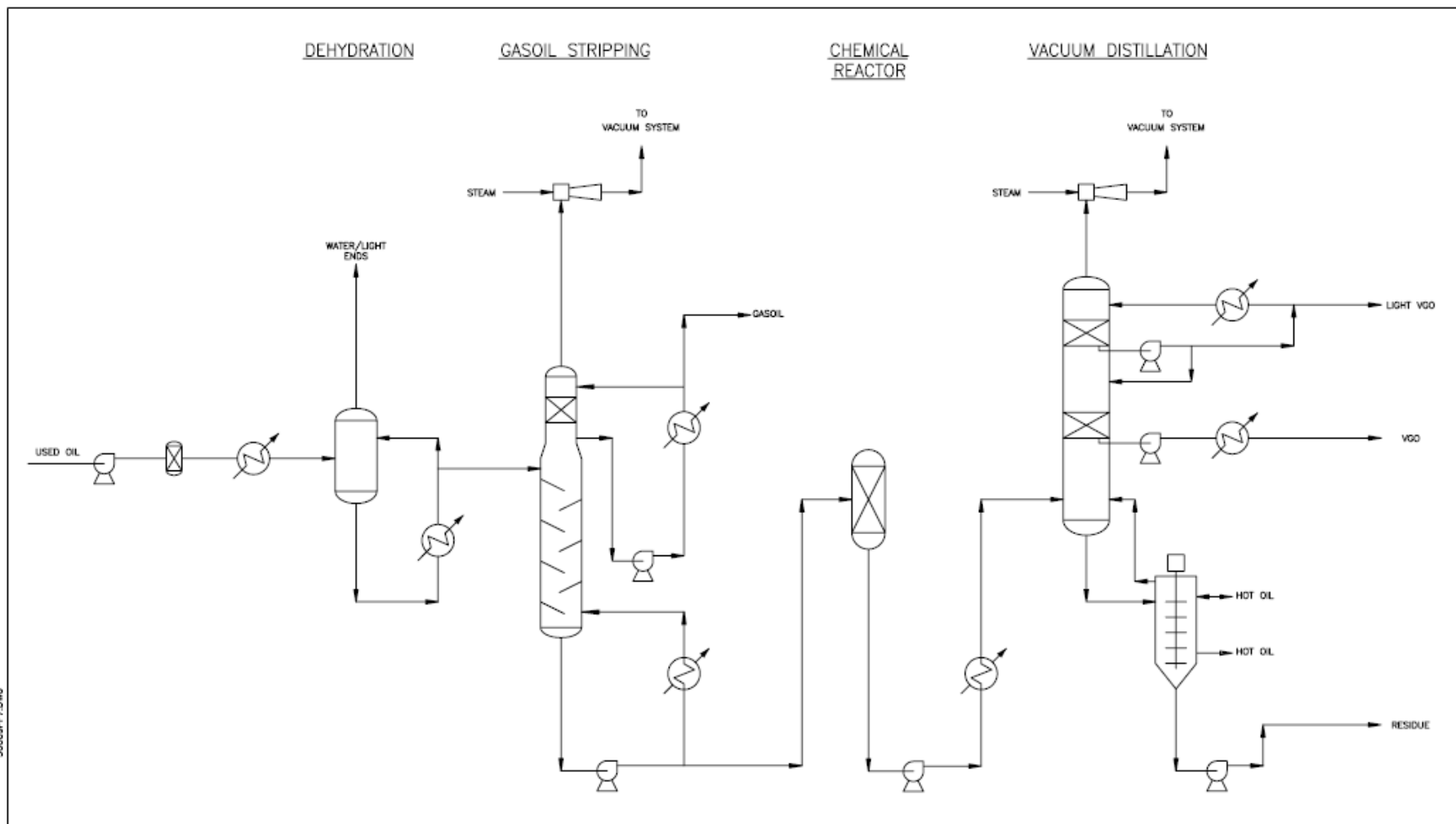

Used Lube Oil Re-refining

Base oil API Group I production

Flow Scheme

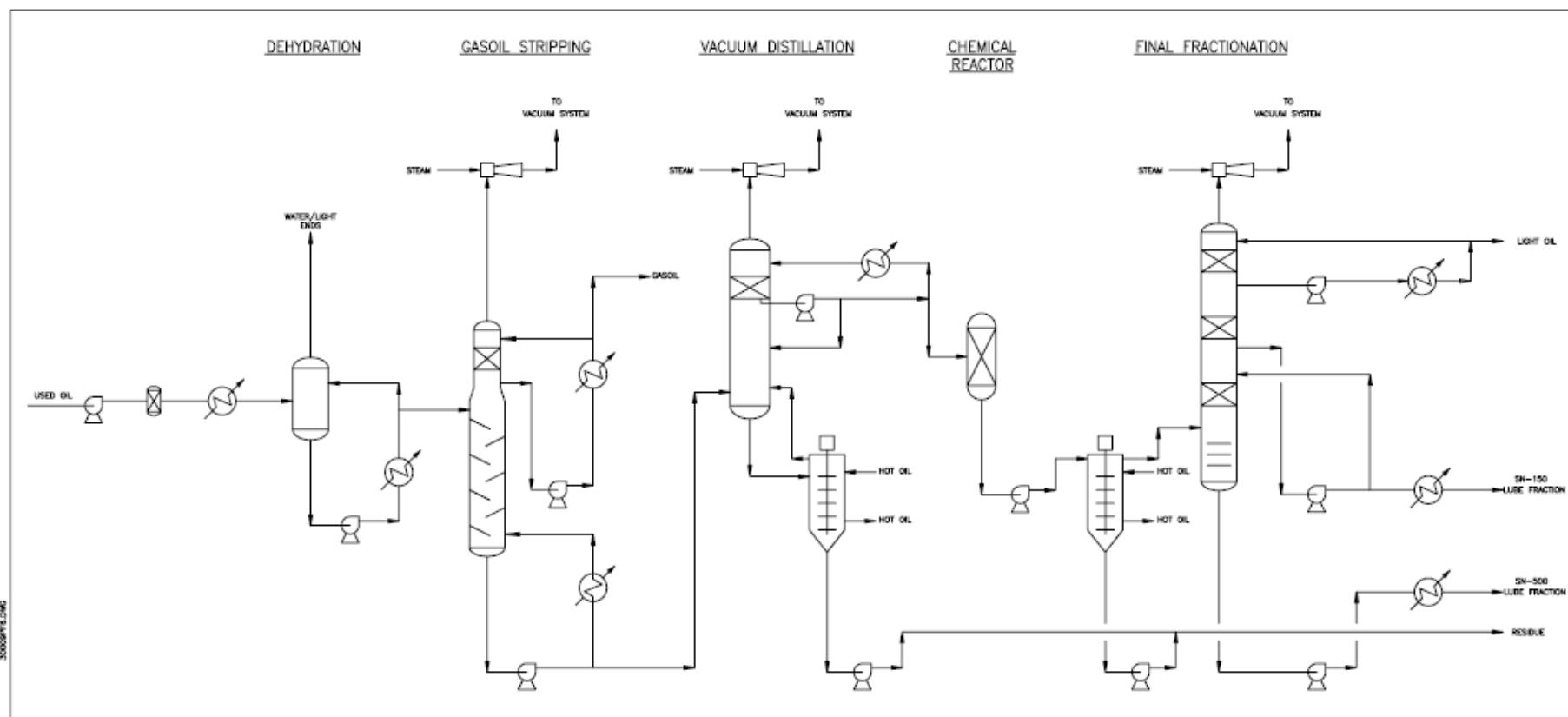



USED LUBE OIL RE-REFINING

Used Lube Oil Re-refining Base oil API Group II production Flow Scheme Hydrofinishing & Fractionation

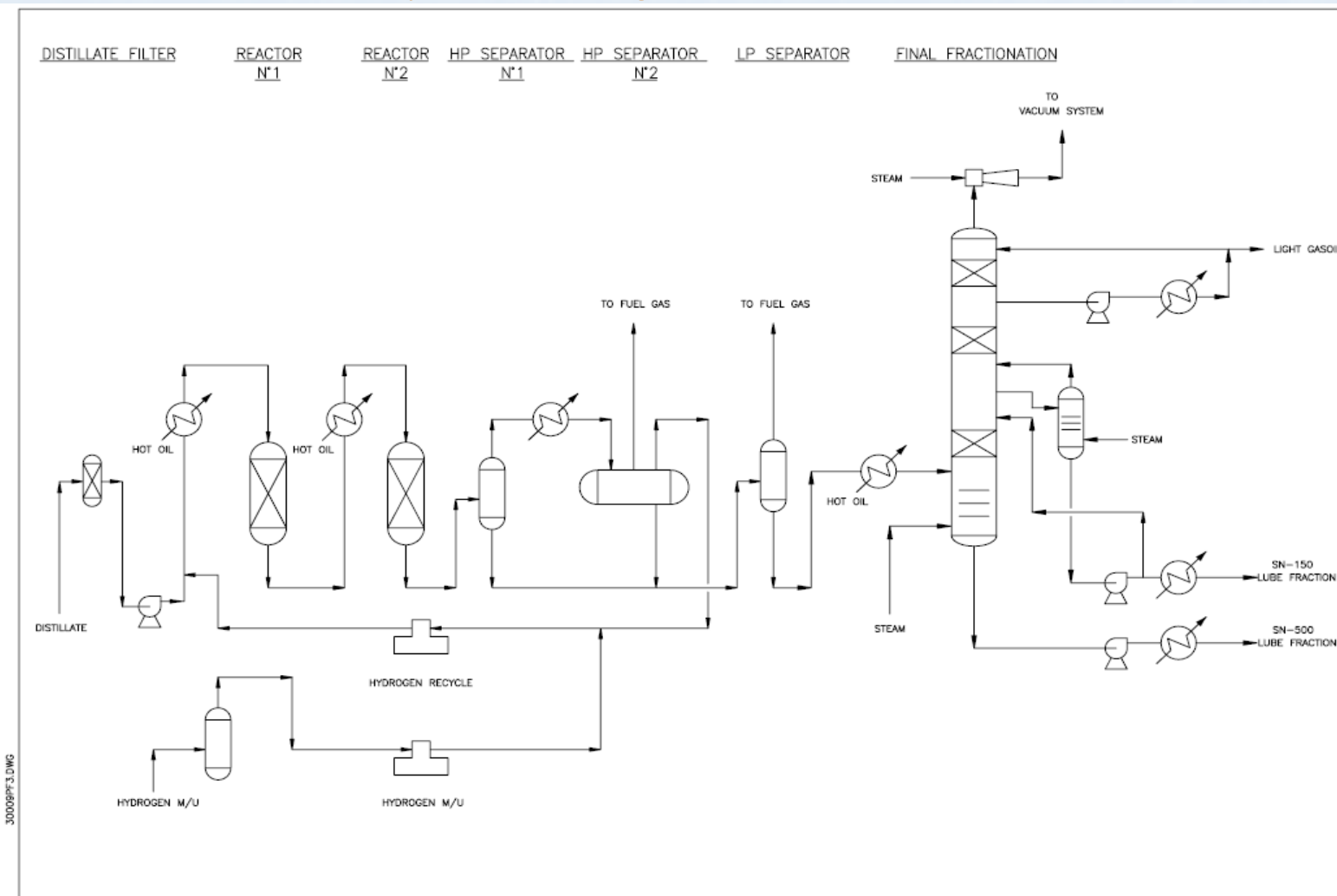



USED LUBE OIL RE-REFINING

Used Lube Oil Re-refining

Base oil API Group II production

Flow Scheme

Distillation

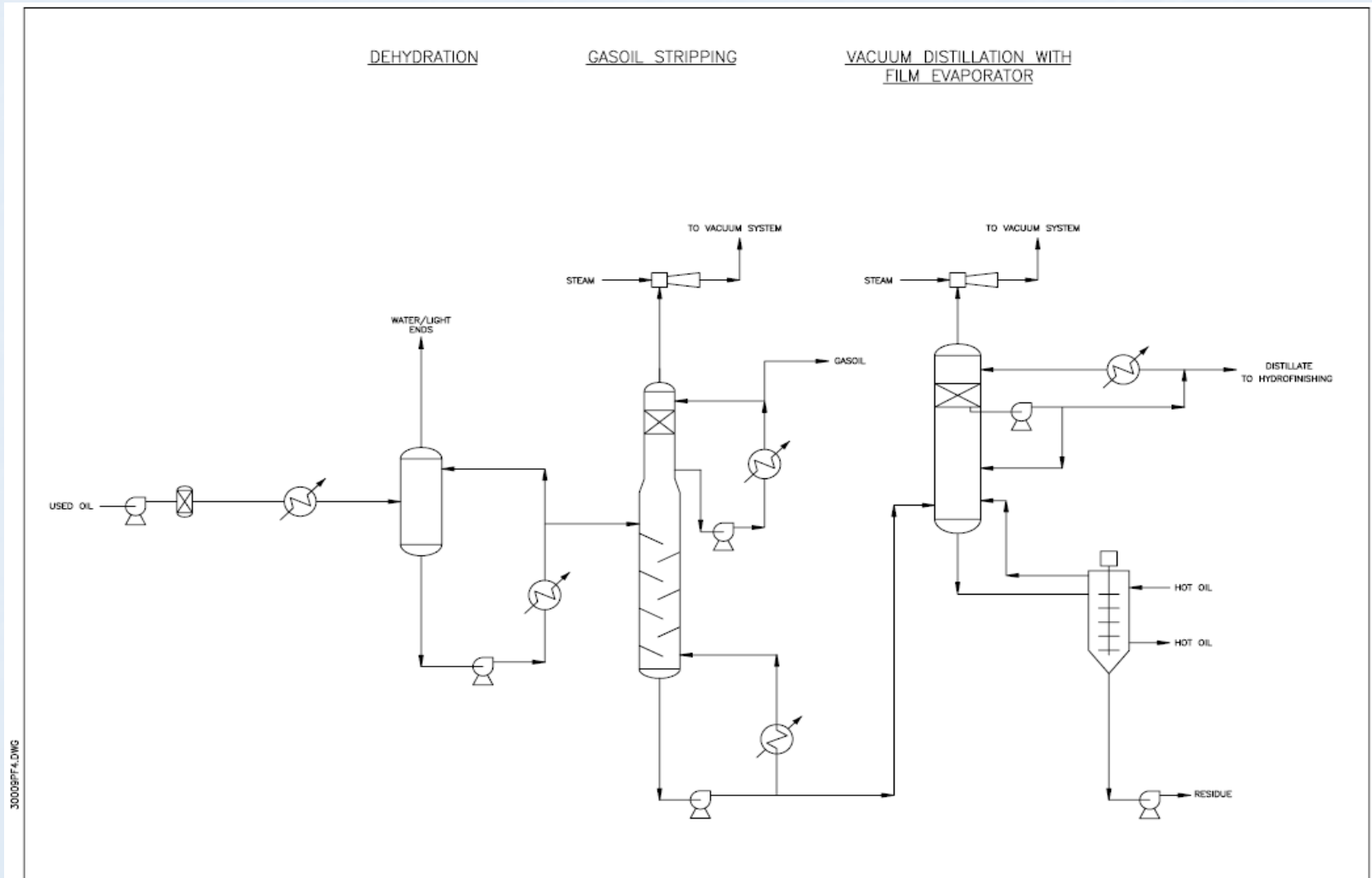



USED LUBE OIL RE-REFINING



Used Lube Oil Re-refining PLANT VIEW AND ELEVATION

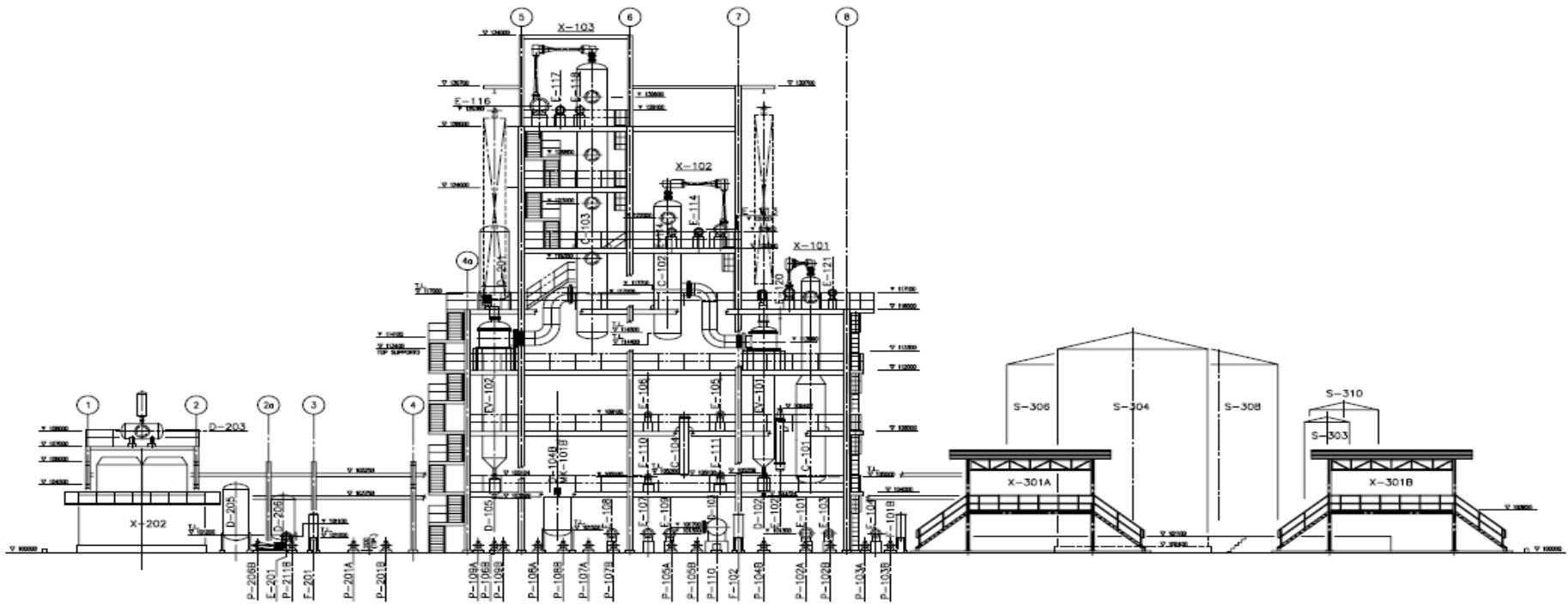



USED LUBE OIL RE-REFINING



Used Lube Oil Re-refining PLANT VIEW AND ELEVATION

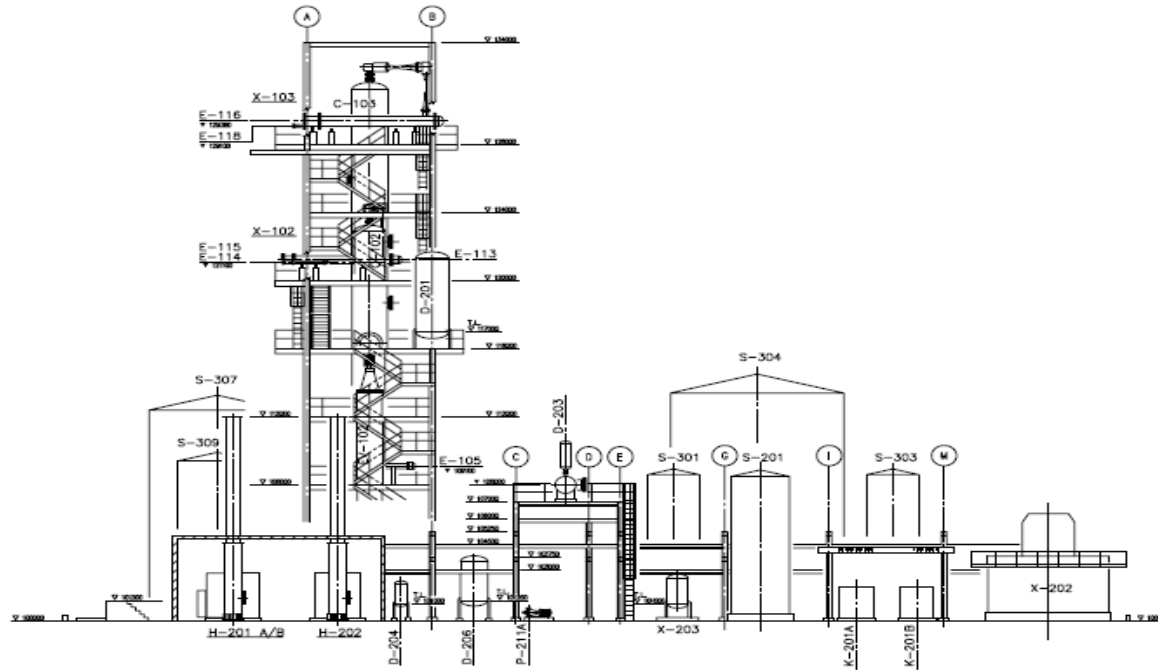



USED LUBE OIL RE-REFINING

Used Lube Oil Re-refining



VACUUM DISTILLATION MODELLING

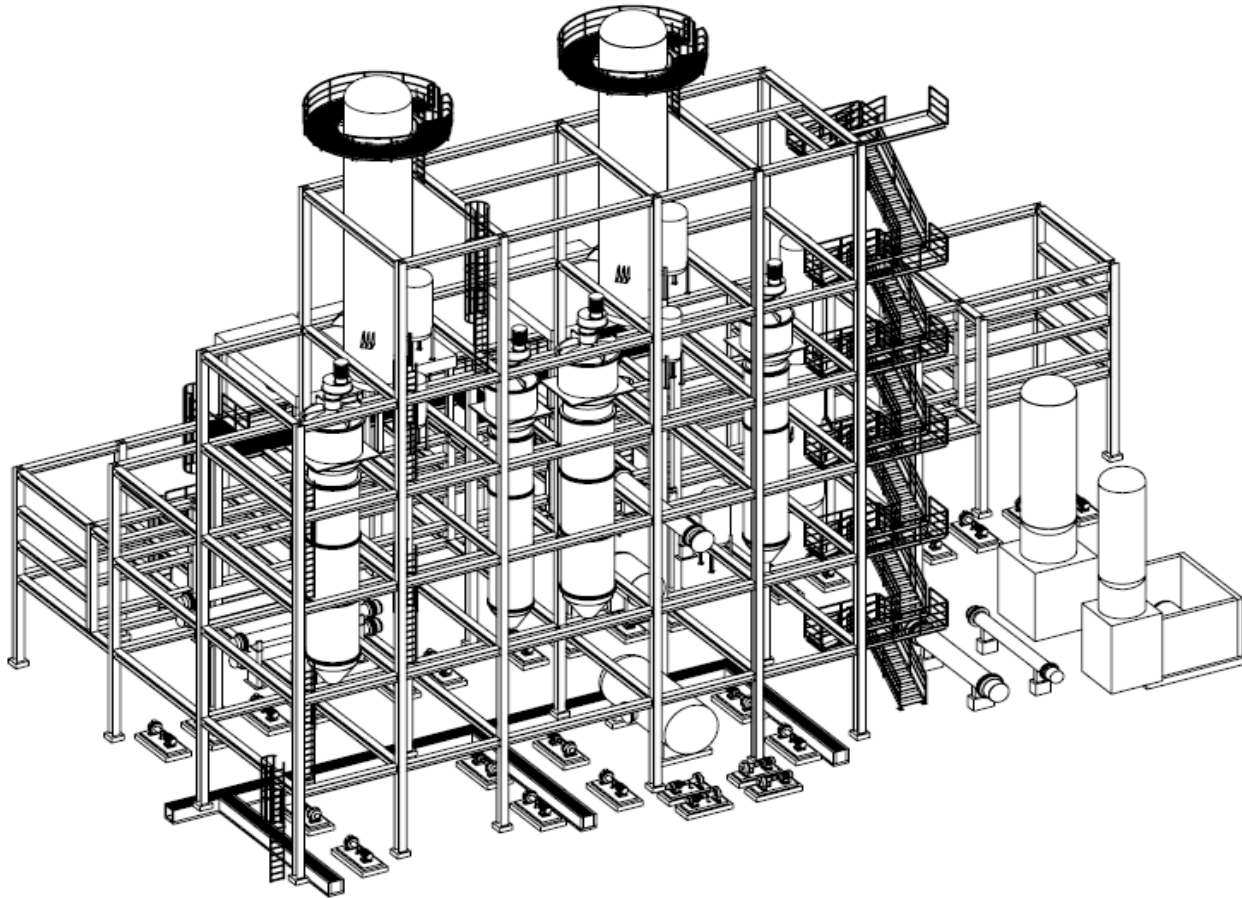



USED LUBE OIL RE-REFINING



STP REFERENCES





USED LUBE OIL RE-REFINING



Client: VEOLIA ES CANADA

Location: St. Hyacinthe, Quebec

Capacity: 60,000 Ton/year

Type of Facility: Used Lube Oil Rerefining for production of VGO

Year: in progress. Completion 2012

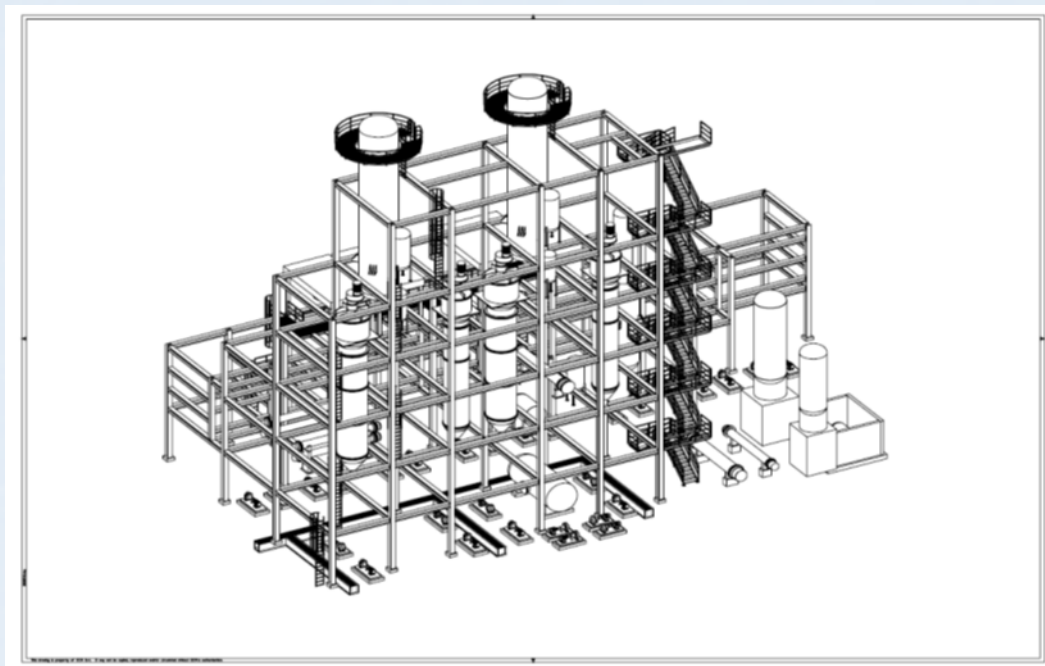

Client: ECOIL

Location: Ferrandina, Italy

Capacity: 65,000 Ton/year

Type of Facility: Used Lube Oil Rerefining for Base Oils production and Blending

Year: in progress. Completion 2012



USED LUBE OIL RE-REFINING



Client: TOTAL / VEOLIA - OSILUB

Location: Gonfreville l'Orcher, France

Capacity: 120,000 Ton/year

Type of Facility: Used Lube Oil Rerefining for production of VGO

Year: in progress. Completion 2011



USED LUBE OIL RE-REFINING



Client: SIRAL S.p.A.

Location: Nola, Italy

Capacity: 30,000 Ton/year

Type of Facility: Used Lube Oil Rerefining for Base Oils production and Blending

Year: 2005-2007



USED LUBE OIL RE-REFINING



Client: **KLOC- KUWAIT LUBE OIL COMPANY**

Location: Ahmadi, Kuwait

Capacity: 27.000 Ton/year

Type of Facility: Used Lube Oil Rerefining for Base Oils Production

Year: 1998-2000



USED LUBE OIL RE-REFINING



Client: SOTULUB – Société Tunisienne de Lubrifiants

Location: Bizerte, Tunisia

Capacity: 20.000 Ton/year (Revamping)

Type of Facility: Used Lube Oil Rerefining for Base Oils production

Year: 1997-1999



USED LUBE OIL RE-REFINING



Client: **GRUPO LWART**

Location: Lencois Paulista, Brazil

Capacity: 60.000 Ton/year

Type of Facility: Used Lube Oil Rerefining for Base Oils production

Year: 1996-1998



USED LUBE OIL RE-REFINING



Client: RAMOIL

Location: Naples, Italy

Capacity: 30,000 Ton/year

Type of Facility: Used Lube Oil Rerefining for Base Oils production and Blending

Year: 1994-1996



USED LUBE OIL RE-REFINING



Client: **KONKAT**

Location: Armavir, Russia

Capacity: 50.000 Ton/year

Type of Facility: Used Lube Oil Rerefining for Base Oils production and Blending

Year: 1991-1993



USED LUBE OIL RE-REFINING



Client: **SOTULUB**- Société Tunisienne de Lubrifiants

Location: Bizerte, Tunisia

Capacity: 16.000 Ton/year

Type of Facility: Used Lube Oil Rerefining for Base Oils production

Year: 1987-1989



USED LUBE OIL RE-REFINING



Client: EKVE/LPC

Location: Aspropyrgos, Greece

Capacity: 25,000 Ton/year

Type of Facility: Used LUBE Oil Rerefining for Base Oils production and Blending

Year: 1983-1985



APPROVAL CERTIFICATES and TEST REPORT

The Re-refined Lube OilS produced by STP process have been approved by USA Department of Army, USA Lubricants Research Institute, Grandi Motori Trieste (Italy), FIAT (Italy), ANSALDO Motori (Italy) and Mercedes Daimler Benz (Germany).

The Approval Certificates and Test Report are available on request.

Certificates and Test Report clearly show that the base oils product are top quality and suitable for motor and industrial application.

Re-refined base oils characteristics and performance are fully equivalent to the virgin Lube Oils.



Carlo G. Lombardi

Carlo G. Lombardi is the Chief Executive Officer and Managing Director of STP, Studi Tecnologie Progetti S.r.l..

He has more than 20 years experience in design and implementation of Used Lube Oil Re-refining Plants and is a recognized worldwide leading expert of Used Lube Oil Re-refining and one of the pioneer of the Re-refining technology based on thin film evaporator and hydrofinishing process.

Mr. Lombardi is author of presentations on Used Lube oil Re-refining and former lecturer at the Industrial Chemistry Institute of Chemical Engineering College at Rome University.

./..



His experience in Lube Oil Technology and Marketing includes:

Technology:

- Process technology development
- Pilot testing for the application of thin film evaporator to Used Lube Oil Re-refining in the year 1980 at HABERLAND Co., Dollbergen, Germany
- Design of the first industrial Re-refining plant in Greece for the former EKVE Industries, at Aspropyrgos, Greece

Marketing and Sales Strategy:

- Cooperation with the Italian “Obligatory Consortium of Used Lube Oil” to set up the procedures and regulation for the collection of the Used Lube Oil in Italy
- Participation with SOTULUB and other Tunisian Lube Oil distribution Companies to the assessment of regulation and quality specification of re-refined lube oil in Tunisia, years 1983-84
- Cooperation with REDOIL Italy, partner of Chall-Oils USA, for finished lubricant formulation, Motor Oil, Transmission Fluids, White Oils, Industrial Oils
- Cooperation with AGIP PETROLI, Italy, on lubricant production, marketing and selling.



Publications and Conferences:

- ❑ *Modification of existing re-refining units and realization of new modular units*, November 11th – 13th, 1999.
- ❑ *The hidden asset*, speech at “Fifth Conference on Spent Lube Oil Re-refining”, Las Vegas, USA, September 1982.
- ❑ *The used lube oil: a resource not to underevaluate*, in “Chemical Industries Magazine”, Italy, February 1982.
- ❑ Report on STP process at “NORA – National Oil Recyclers Association’s 1999 Conference and Trade Show”, Palm Springs, USA, November 1999.



USED LUBE OIL RE-REFINING

STP attendance to NORA Conference at Palm Springs (USA)



National Oil Recyclers Association

12429 Cedar Road • Suite 26 • Cleveland, Ohio 44106-3172 • (216)791-7316 • Fax (216)791-6047
Kathryn McWilliams - Executive Director
E-Mail Address: NatOilIRA@aol.com
www.noraoil.com

February 7, 2000

Carlo Lombardi
STP Studi Tecnici Procedure
Via D Snasotta 100
Rome, Italy 00147

Dear Lombardi:

The National Oil Recyclers Association's 1999 Conference and Trade Show in Palm Springs was a success in part because of fine presentations such as yours. Each Conference we orchestrate is built on the efforts of many individuals and I'd like you to know that your contribution was appreciated.

The Conference was well attended with over 300 people taking part in the meetings, presentations and activities. And, indications are that your presentation was received quite well.

On behalf of the Conference Planning Committee, the attendees and myself, thank you for your participation. We hope you had an enjoyable experience and trust you will consider submitting a presentation proposal for the 2000 Conference.

Sincerely,

Teresa S. Molnar
Program Coordinator

/ter





USED LUBE OIL RE-REFINING

STP attendance to **NORA** Conference at Palm Springs (USA)



1999 LIQUID RECYCLING CONFERENCE AND TRADE SHOW
PALM SPRINGS – November 10 – 13, 1999

**MODIFICATION OF EXISTING REREFINING UNITS
AND REALIZATION OF NEW MODULAR UNITS**

Mr. Carlo G. Lombardi
Chief Executive Officer
S.T.P. - STUDIES TECHNOLOGIES PROJECTS S.r.l. – Rome, Italy



USED LUBE OIL RE-REFINING



CONTACT US



STP – Studi Tecnologie Progetti S.r.l.

Piazzale Ezio Tarantelli, 97

00144 – Rome, Italy

Tel. ++39-06-52201070 (PBX 5 Lines)

Fax. ++39-06-52201078

E-mail: stp@stpitaly.eu

Web Site: www.stpitaly.eu